

DPD Overview

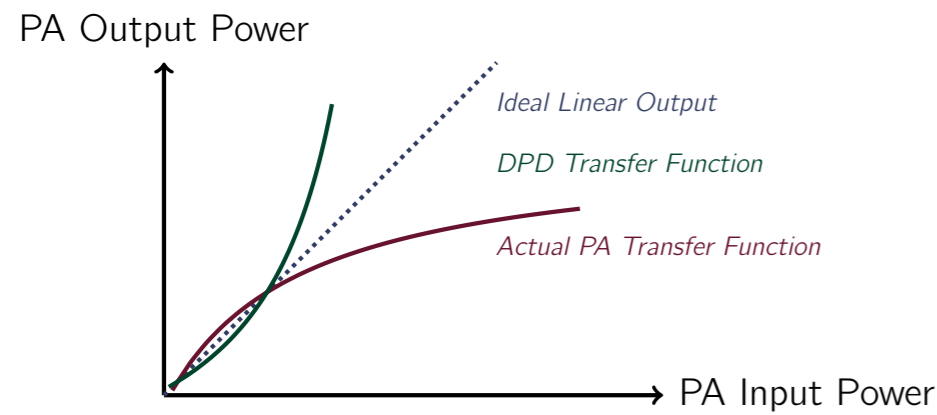

Figure: Example AM/AM Curve for a PA.

- Digital predistortion (DPD) creates an inverse nonlinearity to linearize power amplifier (PA) output.

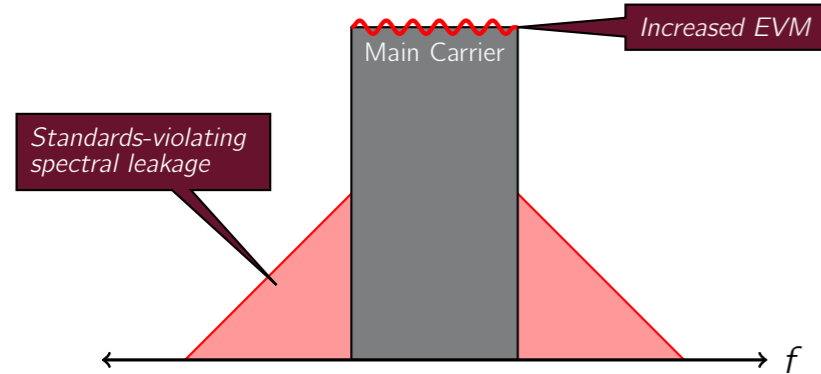
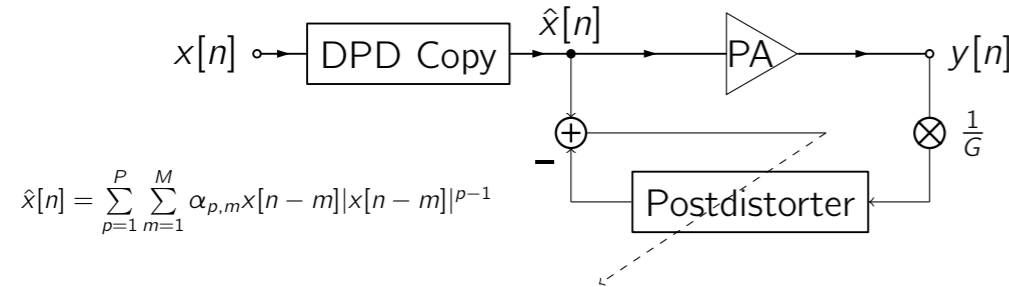

Figure: Without DPD, nonlinearities in the PA create spectral regrowth around a carrier which could violate 3GPP spectral emission masks and degrade EVM.

Challenges:

- High PAPR and wide bandwidths in 5G NR.
- PAs are most efficient near saturation.

Prior Work: Memory Polynomials with ILA



- Learning a post-distorter is not likely to be best predistorter.
- Often introduces bias in solution.

This Work: Novel Neural-Network DPD Solution

Use NN to model a PA and train a NN-based DPD

- Avoids the ILA and associated issues with stability.
- Can outperform for the same complexity.
- Simple implementation with regular matrix-multiply structure and ReLu activation function.

Linear-Bypass Neural-Network Architecture

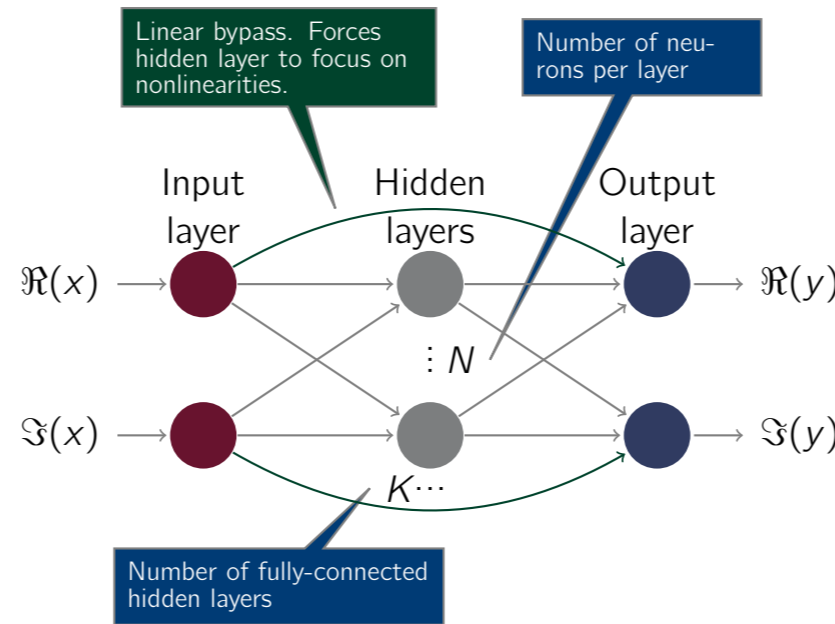

- Replace the memory polynomial with linear-bypass neural networks with ReLu activation functions.

Neural Network Training Method

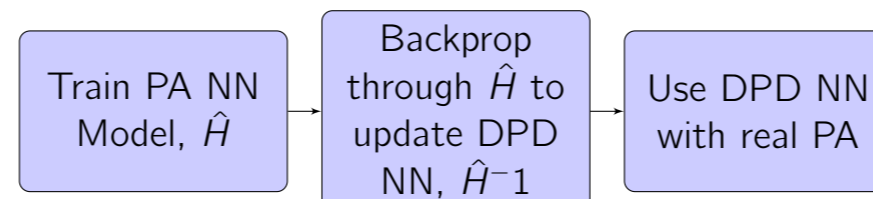

Figure: DPD Training Flow.

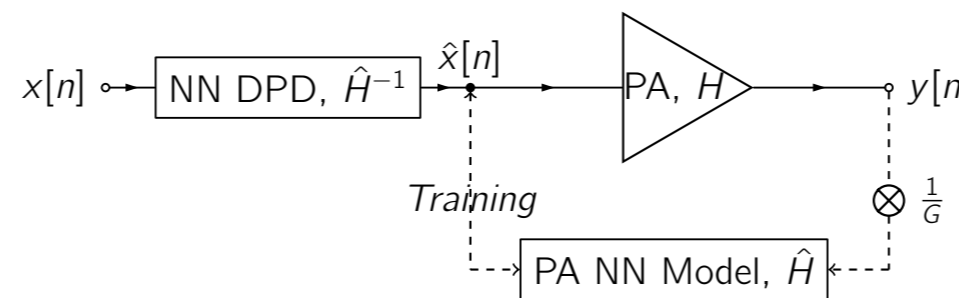
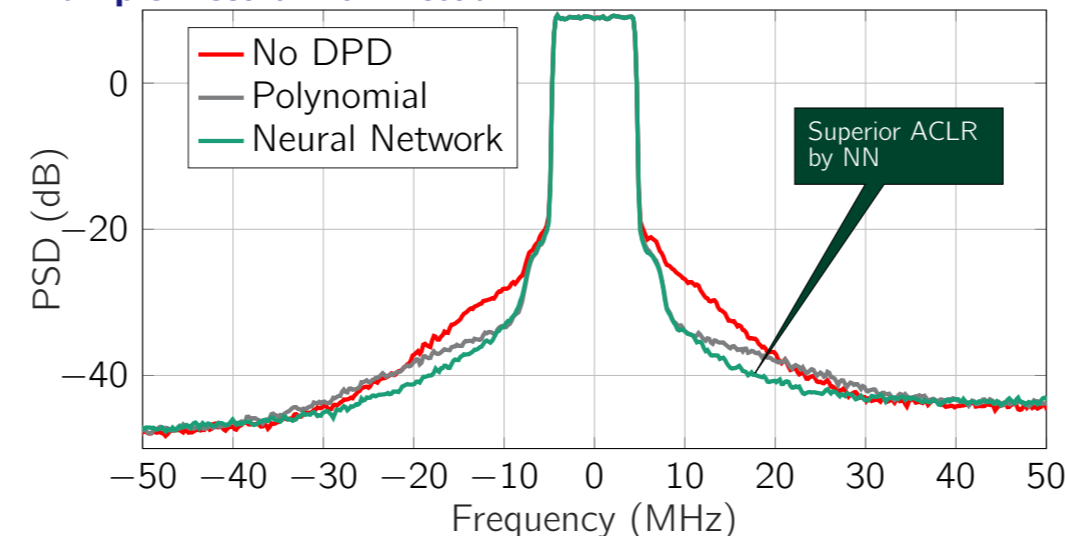

Figure: System Diagram

Example Result with Actual PA



- Use 10 MHz 5G NR-like signal
- Test with Cree 6W GaN PA using RFWebLab
- Same complexity for each predistorter

Why Does the Neural Network Outperform the MP?

- Train a MP and NN based DPD on 10 MHz NR with RFWebLab
- Compare the outputs of the predistorters over a testgrid over the IQ plane.

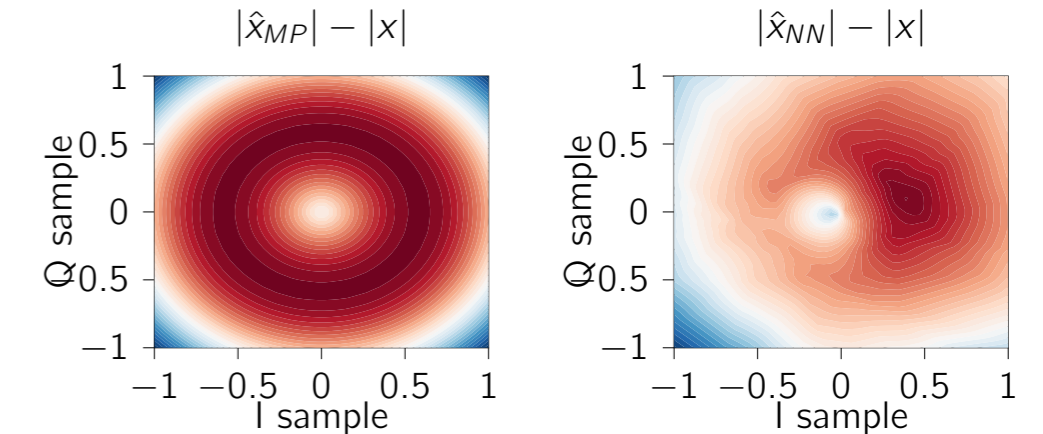

(a) Polynomial DPD. Max = 0.03.

(b) NN-based DPD. Max = 0.06.

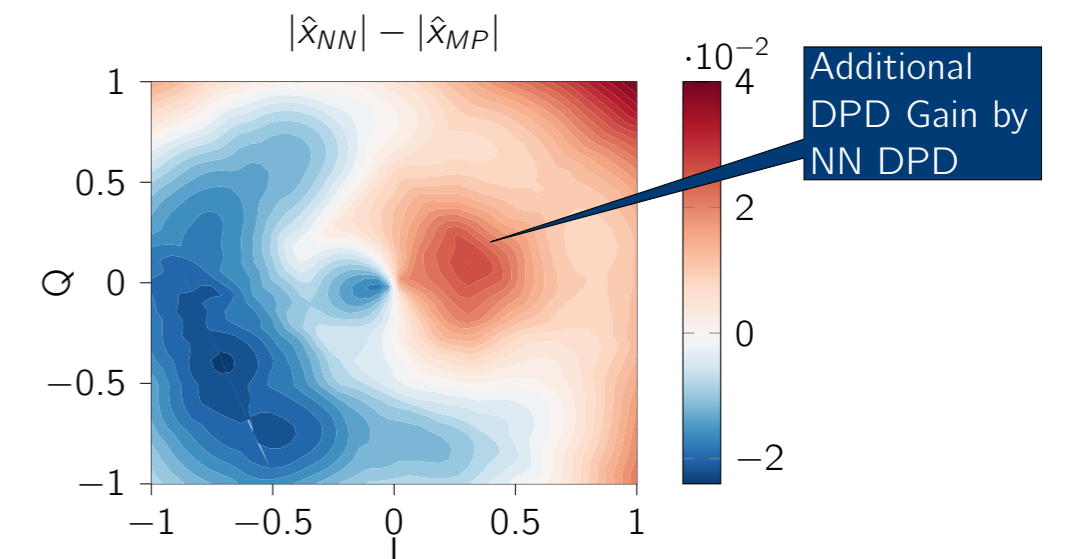

Figure: Difference in predistortion between NN and MP DPDs over the IQ plane

- Small difference in the outputs of the two predistorters.
- The NN predistorts based on phase of input.
- This effect is persistent but with random rotations on subsequent runs.

Conclusions

- Neural networks offer a flexible and precise method of modeling a PA and creating a predistorter.
- A linear bypass in the NN reduces complexity.
- NNs offer lower complexity for similar performance.
- There are phase dependent effects that are critical for predistortion performance.

Future Work:

- Addition of memory effects to neural networks.
- Testing on more devices such as WARP and IRIS SDRs